

NOTE:
Please read all instructions
carefully before using this
product



MARCY

MARCY REM

Safety Notice
Overview Drawing
Parts List
Hardware P/L
Assembly Instruction
Operation
Computer
Fitness Tips
Warranty
Ordering Parts

Model
AY 1021

Retain This
Manual for
Reference

8-02-99

OWNER'S
MANUAL

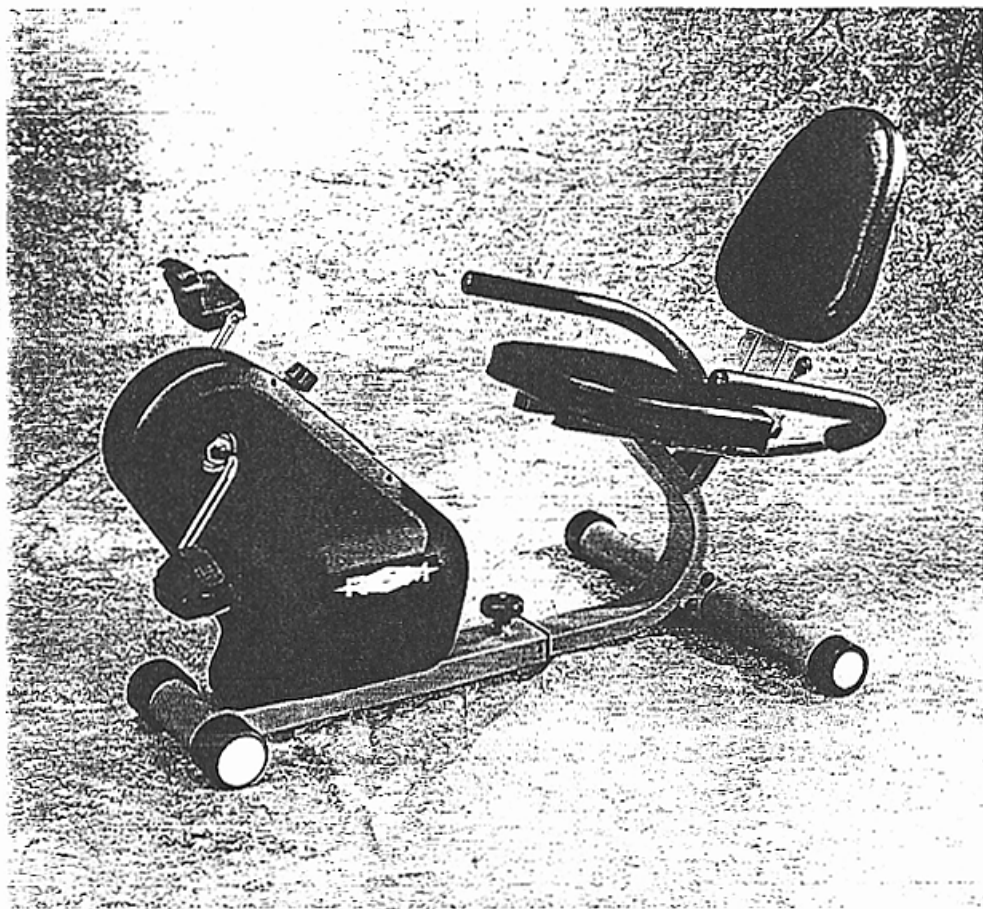

IMPEX FITNESS PRODUCTS

14777 DON JULIAN RD., CITY OF INDUSTRY, CA 91746

Tel: (800) 999-8899 Fax: (626) 961-9966

www.impex-fitness.com
impex@impex-fitness.com

SAFETY NOTICE

This exercise equipment was designed and built for optimum safety. However, certain precautions apply whenever you operate a piece of exercise equipment. Be sure to read the entire manual before assembly and operation of this machine. Also, please note the following safety precautions:

1. Keep children and pets away from this equipment at all times.
2. Only one person at a time should use this equipment.
3. If dizziness, nausea, chest pains, or any other abnormal symptoms are experienced while using this equipment, **STOP** the workout at once. **CONSULT A PHYSICIAN IMMEDIATELY.**
4. Always use this equipment on a clear and level surface. Do not use outdoors or near water.
5. Keep hands and feet away from any moving parts.
6. Do not insert any object into any openings.
7. Read all instructions before assembly and operation.
8. Before using this equipment to exercise, always do stretching exercises to properly warm up.
9. Use this equipment only for its intended use as described in this manual.
10. Always wear appropriate workout clothing and shoes when exercising. Do not wear robes or other clothing that could become caught in the equipment.

NOTE : Maximum weight capacity for this product is **250LBS/110KGS.**

WARNING : Before beginning any exercise program consult your physician. This is especially important for individuals over the age of 35 or persons with preexisting health problems. Read all instructions before using any fitness equipment. Do not operate this exercise equipment without properly fitted guards, as the moving parts can present a risk of serious injury to young children.

CAUTION : Read all instructions carefully before operating this product. Retain this Owner's Manual for future reference.



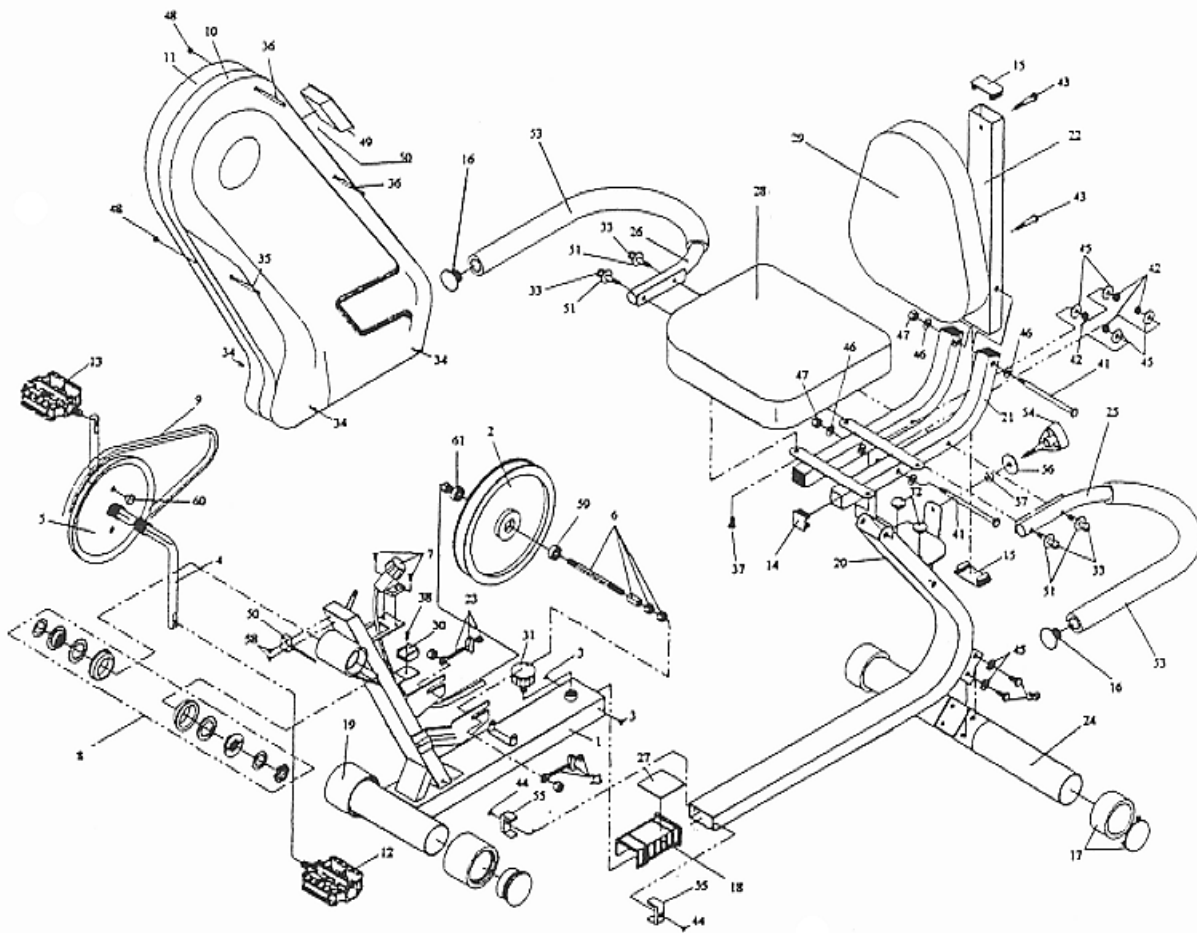



OVERVIEW DRAWING

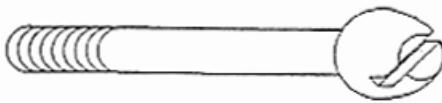
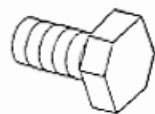

PARTS LIST

Part#	Description	Q'ty	Part#	Description	Q'ty
1	Main frame	1	32	Plastic stop under seat frame	2
2	Flywheel W/Freewheel	1		(flat, round)	
3	Screw	2	33	M8 by 70mm bolt	4
4	Crank	1	34	5mm by 20mm screw	4
5	Pully	1	35	5mm by 66mm screw	1
6	Axle	1	36	5mm by 76mm screw	2
7	Tension knob with belt	1	37	8mm by 14mm screw	4
8	Bottom bracket bearing set	1	38	5mm by 12mm screw	1
9	Belt	1	39	8mm by 14mm bolt	4
10	Flywheel housing (left)	1	40	Hardware pack	1
11	Flywheel housing (right)	1	41	10mm by 138mm bolt	2
12	Left pedal	1	42	M8 nylon nut	4
13	Right pedal	1	43	8mm by 40mm screw	2
14	30mm by 30mm endcap	4	44	4mm by 10mm screw	4
15	30mm by 60mm endcap	2	45	M8 washer	8
16	25mm endcap dia	2	46	M10 washer	4
17	Foot for Front leg with plastic insert	2	47	Lock nut for M10 bolt	2
18	Plastic insert for sliding rectangular tubing	1	48	M5 nut	3
			49	Computer	1
19	Foot for front leg(rolling)	2	50	Sensor with wire	1
20	Base frame	1	51	M8 curved washer	4
21	Seat frame	1	52	N/A	
22	Back pad tubing	1	53	Foam roller	2
23	M6 Hook Set	2	54	5/16 inch knob	1
24	Rear base leg	1	55	Stopper inside of base frame	2
25	Left arm	1	56	5/16 inch washer	1
26	Right arm	1	57	Plastic retaining ring for knob	1
27	Steel plate in adjustable base tubing	1	58	3mm by 12mm screw	2
28	Seat pad	1	59	Bearing 6000ZZ	1
29	Back pad	1	60	Magnet	1
30	Plastic clip for end of belt	1	61	Bearing 6000ZZ	1
31	Knob	1	62	Manual	1

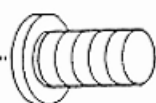
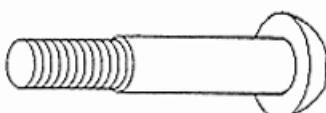
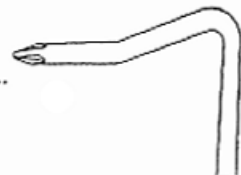
HARDWARE PACKING LIST

Part#	Description	Quantity
33	M8 by 70mm bolt 	4
39	8mm by 14mm bolt 	4
42	M8 nylon nut 	4
45	M8 washer 	8
51	M8 curved washer 	4
37	M8 by 14mm Screw 	4
43	M8 by 40mm Screw 	2
	Screwdriver 	1
	Fixed spanner 	1

NOTE : 1. The Above described parts are all you need to assemble this machine. Before start assembling, please check the hardware packing to make sure they are included.

2. All the other parts described on page 3(parts list) are pre-assembled in the factory.

ASSEMBLY INSTRUCTION

This manual is designed to help you easily assemble, adjust, and use this machine. Please read this manual carefully. Please first study the overview drawing to familiarize yourself with the parts.

Set all parts in a clear area on the floor and remove the packing materials. Refer to the parts list for help to identify the parts. To assemble the machine, see the following.

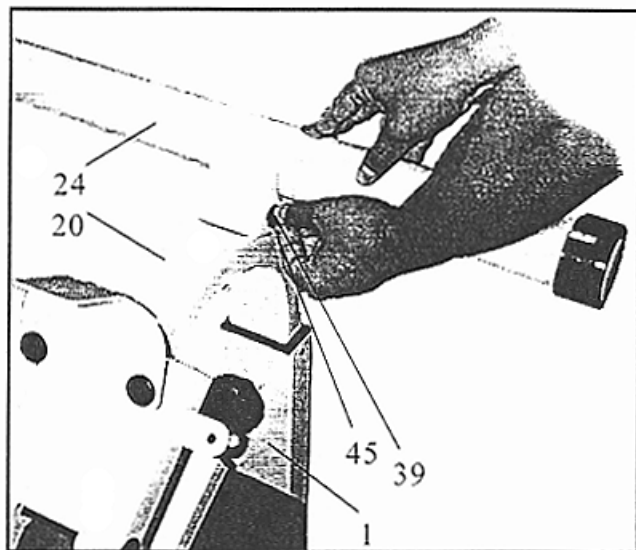

Step 1

Connect the rear base leg (24) to the main frame (1) using four bolts (39) and four washers (45).

Note : Firmly tighten the four bolts.

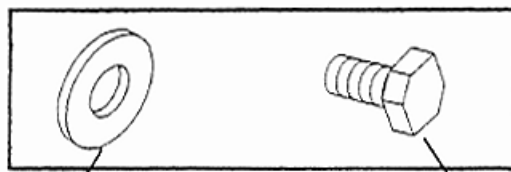

[45] M8 washer [39] 8mm by 14mm bolt

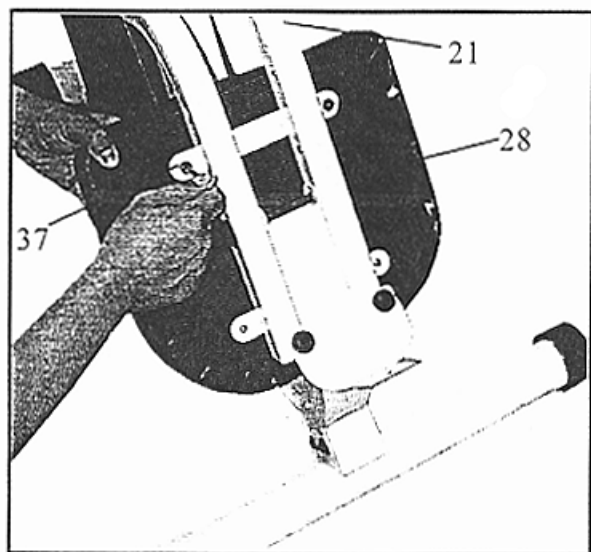

Step 2

Connect the seat pad (28) to the seat frame (21) using four screws (37). Tighten all four screws firmly.

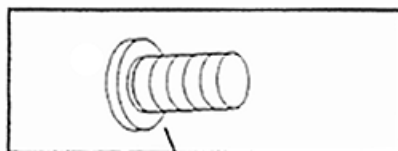

[37] M8 by 14mm Screw

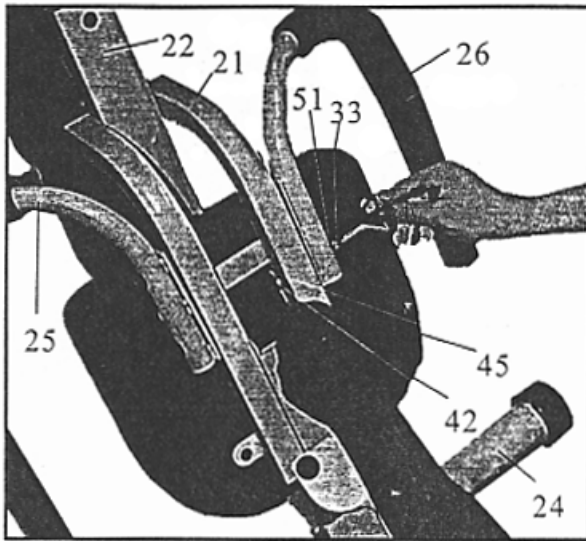

Step 3

Attach handlebars to the main frame with two M8 by 70mm bolts (33), two curved washers (51), two M8 washers (45) and two M8 nylon nuts (42) per side as shown.

Note : The curve of the handlebar must face upward.

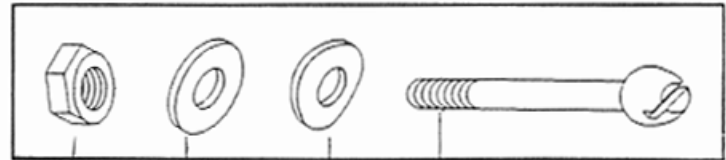

[33] M8 by 70mm bolt

[51] M8 curved washer

[45] M8 washer

[42] M8 nylon nut

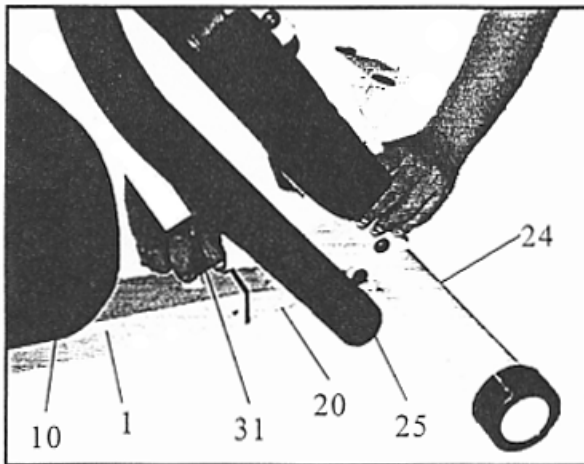

Step 4

Loosen the knob (31) on the main frame (1). Slide the base frame (20) back away from the flywheel housing (10&11).

Note : Firmly tighten the knob.



Step 5

- Use one hand to hold the seat pad (28) and the other to hold the back pad tubing (22).

- Lift up on the back pad (29) by rotating it into place.

Note : Firmly tighten the knob (54) on the back pad tubing.

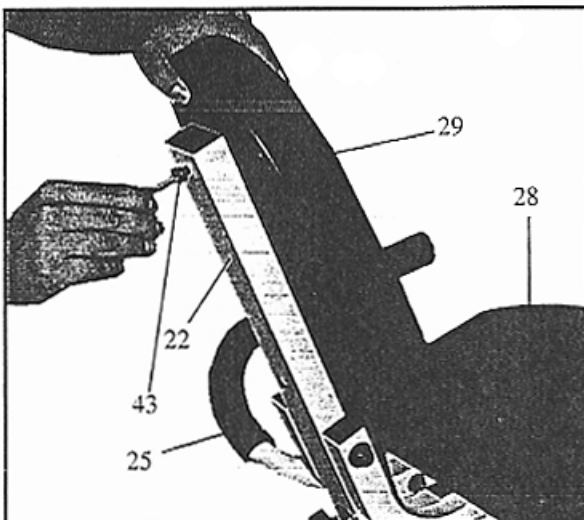
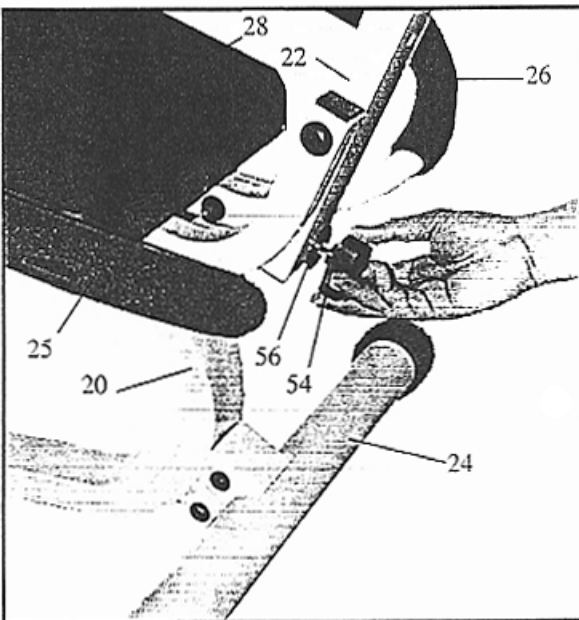

Step6

Connect the back pad (29) to the back pad tubing (22) using two screws (43). Tighten both screws firmly.

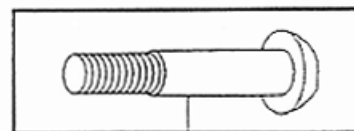

[43] M8 by 40mm Screw

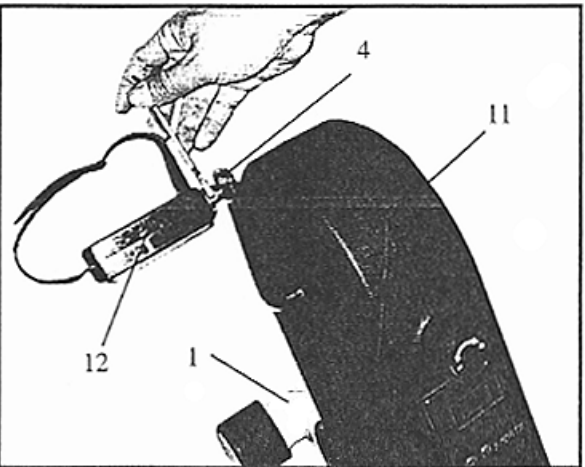
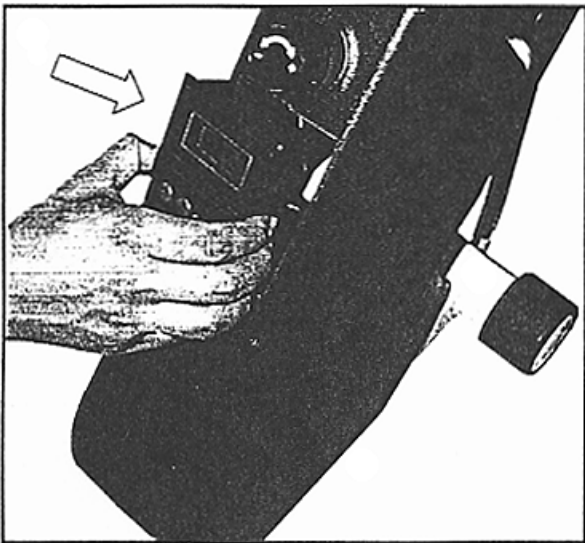
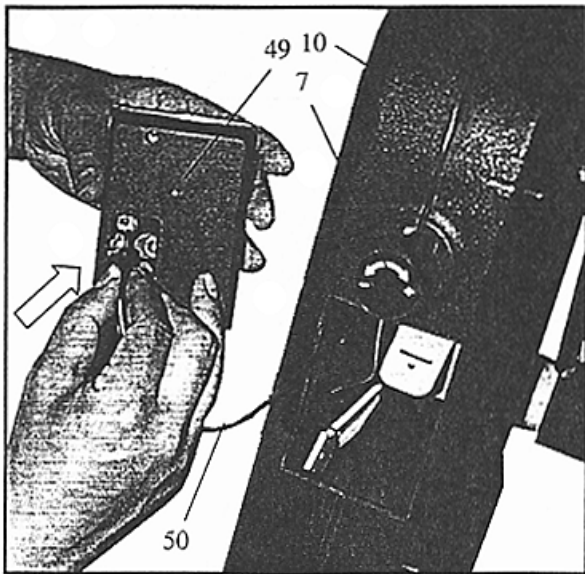

Step 7

- The computer (49) is packaged separately inside the carton. Remove the plastic cover on the back of the computer (49). Place two "AA" batteries into the housing. Make sure the polarity markings on the batteries (+/-) match up with those on the housing.
- Reconnect the plastic cover on the back of the computer. Connect the sensor wire (50), located just inside the flywheel housing (10&11), into the back of the computer. Now snap the computer into the flywheel housings.

Step 8

- Connect the right pedal (13) to the side of crank(4) on the main frame (1) assembly where you would position your right foot when exercising. Thread it into the crank assembly in the clockwise direction.
- Now connect the left pedal (12) to the left hand side of the crank assembly by threading it in the counter-clockwise direction.

Note : Be sure to double check that the left pedal is Marked "L", and the right pedal " R". Then firmly tighten both pedals.

OPERATION

Adjusting the tension control knob :

For more resistance, rotate the tension control knob (7) clockwise. For less, rotate the tension control knob counter-clockwise.

Folding up for storage :

- Loosen the knob (54)..
- Rotate the back pad tubing (22) forward until the seat pad (28) and back pad (29) are rotated as far as they will go.
- Loosen the knob (31) and slide the base frame (20) forward as far as it will go.

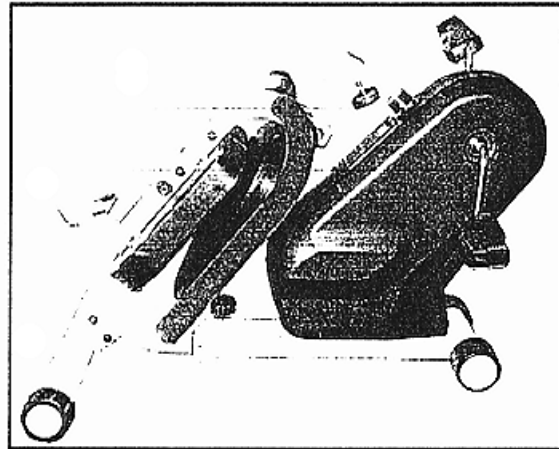
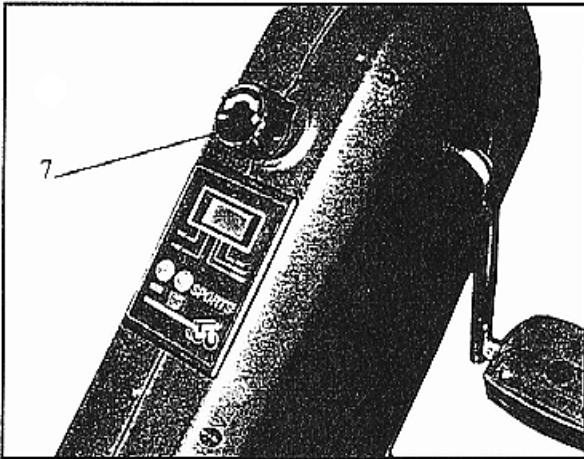

Storing your foldable recumbent bike :

- Fold up the bike as above. Lift up on the rear base leg (24).
- Use the foot for front legs (19) to roll your bike to the desired position.

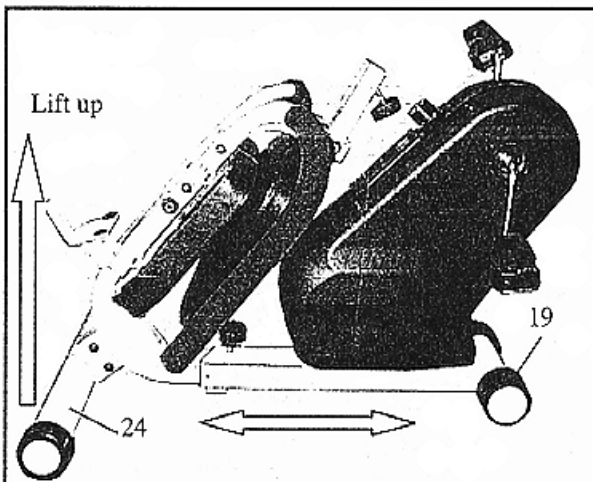

COMPUTER

Function button

- Mode : Press to select each function.
- Reset : Press to reset each function.

Functions

- Scan : Automatically scan through each mode in sequence every 6 seconds.
- Time : Accumulates total time up to 99:59.
- Speed : Accumulates the current speed up to 99.9 KM/H or ML/H.
- Distance : Accumulates total distance up to 99.99 KM or ML from zero.
- Calorie : Accumulates calories consumption during exercise, max value is 9999 cal.
(This data is a rough guide for comparison of different exercise sessions which can not be used in medical treatment).

NOTE :

1. The computer will automatically shut off after 4 minutes when not in use.
2. To start the computer press any button or start pedaling.
3. The computer uses (2) AA batteries..

FITNESS TIPS

Consult your physician

Before using this product, please consult your personal physician for a complete physical examination. Frequent and strenuous exercise should be approved by your doctor. If any discomfort should result from your use of this product, stop exercising and consult your doctor. Proper usage of this product is essential. Please read your manual carefully before exercising. Please keep all children away from the equipment during use and when equipment is unattended.

Dress comfortably

Always wear appropriate clothing, including athletic shoes, when exercising. Do not wear loose clothing that could become caught during exercise.

Check your equipment

Make sure that all bolts and nuts are tightened when equipment is in use. Periodic maintenance is required on all exercise equipment in order to keep it in good condition.

Begin at your Fitness level

How you begin your exercise program depends on your physical condition. If you have been inactive for several years, or are severely overweight, you must start slowly and increase your time gradually, a few minutes per week.

Initially you may be able to exercise only for a few minutes in your target zone; however, your aerobic fitness will improve over the next six to eight weeks. Don't be discouraged if it takes longer. It's important to work at your own pace. Ultimately you'll be able to exercise continuously for 30 minutes. The better your aerobic fitness, the harder you'll have to work to stay in your target zone. But remember these essentials.

Contact your physician before starting a workout or training program. Have him review your training and diet programs to advise you on a workout routine you should adopt.

Begin your training program slowly with realistic goals that have been set by you and your physician. Supplement your program with some type of aerobic exercise such as: Walking, Jogging, Swimming, Dancing and Bike Riding.

Monitor your pulse frequently. If you do not have an electronic heart rate monitor, have your physician show you the proper way to manually check your pulse by using your wrist or neck. Establish your target heart rate based on your age and condition.

Drink plenty of fluids during the course of your routine. You must replace the water content that you have lost from excessive exercising to avoid dehydration. Fluids should be room temperature when consumed.. Avoid drinking large amounts of cold liquids.

Check your pulse

To make sure your heart is beating in its target zone, you'll need to know how to monitor your heart rate. The easiest way is to feel the pulse in the carotid artery on either side of your neck, between the windpipe and the large neck muscles. Count the number of beats in ten seconds, then multiply by six. This gives you the number of beats per minute.

Exercising in your target zone

How fast should your heart beat during aerobic exercise? Fast enough to reach and stay in its "target zone", a range of beats per minute that is largely determined by our age and physical condition. To determine your target zone, consult the chart we provide.

Age	Target HR Zone 50-75% (Beats Per Minute)	Average Maximum Heart Rate 100%
20 years	100-150	200
25 years	98-146	195
30 years	95-142	190
35 years	93-138	185
40 years	90-135	180
45 years	88-131	175
50 years	85-127	170
55 years	83-123	165
60 years	80-120	160
65 years	78-116	155
75 years	75-113	150

COPYRIGHT©1997 AMERICAN HEART ASSOCIATION

Warming cool down

A successful exercise program consists of a warm-up, aerobic exercise, and a cool-down. Do the entire program at least two or preferably three times a week, resting for a day between workouts. After several months you can increase your workouts to four or five times per week. Warming up is an important part of your workout, and should begin every session. It prepares your body for more strenuous exercise by heating up and stretching out your muscles. At the end of your workout, repeat these exercises to reduce sore muscle problems. We suggest the following warm-up and cool-down exercises:

Head rolls

Rotate your head to the right for one count, feeling the stretch up the left side of your neck. Next rotate your head back for one count, stretching your chin to the ceiling and letting your mouth open. Rotate your head to the left for one count, and finally; drop your head to your chest for one count.



Shoulder lifts

Lift your right shoulder up toward your ear for one count. Then lift your left shoulder up for one count as you lower your right shoulder.



Side stretches

Open your arms to the side and continue lifting them until they are over your head. Reach your right arm as far upward toward the ceiling as you can for one count. Feel the stretch up your right side. Repeat this action with your left arm.



Quadriceps stretch

With one hand against a wall for balance, reach behind you and pull your right foot up. Bring your heel as close to your buttocks as possible. Hold for 15 counts and repeat with left foot up.



Inner thigh stretch

Sit with the soles of your feet together with your knees pointing outward. Pull your feet as close into your groin as possible. Gently push your knees toward the floor. Hold for 15 counts.



Toe touches

Slowly bend forward from your waist, letting your back and shoulders relax as you stretch toward your toes. Reach down as far as you can and hold for 15 counts.

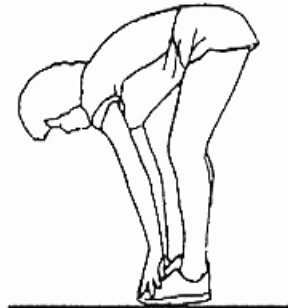

Hamstring stretches

Sit with your right leg extended. Rest the sole of your left foot against your right inner thigh. Stretch toward your toe as far as possible. Hold for 15 counts. Relax and then repeat with left leg extended.



Calf/Achilles stretch

Lean against a wall with your left leg in front of the right and your arms forward. Keep your right leg straight and the left foot on the floor; Then bend the left leg and lean forward by moving your hips toward the wall. Hold, then repeat on the other side for 15 counts.



Aerobic exercise

Aerobic exercise is any sustained activity that sends oxygen to your muscles via your heart and lungs-your body's most important muscle. Aerobic fitness is promoted by any activity that uses your large muscles-arms, legs, or buttocks, for example. Your heart beats quickly and you breathe deeply. An aerobic exercise should be part of your entire exercise routine.

Weight training

Along with aerobic exercising which helps get rid of and keep off the excess fat that our bodies can store, training is an essential part of the exercise routine process. Weight training helps tone, build and strengthen muscle. If you are working above your target zone, you may want to do a less amount of reps. And as always, consult your physician before beginning any exercise program.

IMPEX INC.

LIMITED WARRANTY

IMPEX Inc. ("IMPEX") warrants this product to be free from defects in workmanship and material, under normal use and service conditions, for a period of two years on the Frame from the date of purchase. This warranty extends only to the original purchaser. IMPEX's obligation under this Warranty is limited to replacing or repairing, at IMPEX's option.

All returns must be pre-authorized by IMPEX. Pre-authorization may be obtained by calling IMPEX Customer Service Department at 1-800-999-8899. All freights on products returned to IMPEX must be prepaid by the customer. This warranty does not extend to any product or damage to a product caused by or attributable to freight damage, abuse, misuse, improper or abnormal usage or repairs not provided by a IMPEX authorized service center or for products used for commercial or rental purposes. No other warranty beyond that specifically set forth above is authorized by IMPEX.

IMPEX is not responsible or liable for indirect, special or consequential damages arising out of or in connection with the use or performance of the product or other damages with respect to any economic loss, loss of property, loss of revenues or profits, loss of enjoyments or use, costs of removal, installation or other consequential damages or whatsoever natures. Some states do not allow the exclusion or limitation of incidental or consequential damages. Accordingly, the above limitation may not apply to you.

The warranty extended hereunder is in lieu of any and all other warranties and any implied warranties of merchantability or fitness for a particular purpose is limited in its scope and duration to the terms set forth herein. Some states do not allow limitations on how long an implied warranty lasts. Accordingly, the above limitation may not apply to you.

This warranty gives you specific legal right. You may also have other rights which vary from state to state.

IMPEX INC.
14777 Don Julian
City of Industry, CA 91746

ORDERING REPLACEMENT PARTS

Replacement parts can be ordered by calling our Customer Service Department toll-free at 1-800-999-8899 during our regular business hours: Monday through Friday, 9 am until 5 pm Pacific standard time.

www.impex-fitness.com
impex@impex-fitness.com

When ordering replacement parts, always give the following information.

1. Model
2. Description of Parts
3. Part Number
4. Date of Purchase